

A New Hybrid of Photovoltaic-thermoelectric Generator with Hot Mirror as Spectrum Splitter

by Wahyu Piarah 2

FILE	ERMoelectric_GENERATOR_WITH_HOT_MIRROR_AS_SPECTRUM_SPLITTER.PDF (1.88M)	WORD COUNT	3385
TIME SUBMITTED	04-SEP-2019 07:30PM (UTC+0700)	CHARACTER COUNT	16999
SUBMISSION ID	1167091693		

4
A New Hybrid of Photovoltaic-thermoelectric Generator with Hot Mirror as Spectrum Splitter

Mustofa,^{1*} Zuryati Djafar,¹ Syafaruddin² and Wahyu Haryadi Piarah¹

¹Department of Mechanical Engineering, Universitas Hasanuddin, Jl. Perintis Kemerdekaan Km. 10, Tamalanrea Indah, Kota Makassar, Sulawesi Selatan 90245, Gowa, Indonesia

²Department of Electrical Engineering, Universitas Hasanuddin, Jl. Perintis Kemerdekaan Km. 10, Tamalanrea Indah, Kota Makassar, Sulawesi Selatan 90245, Gowa, Indonesia

¹⁹
*Corresponding author: mustofa@untad.ac.id

Published online: 30 July 2018

To cite this article: Mustofa et al. (2018). A new hybrid of photovoltaic-thermoelectric generator with hot mirror as spectrum splitter. *J. Phys. Sci.*, 29(Supp. 2), 63–75, <https://doi.org/10.21315/jps2018.29.s2.6>

To link to this article: <https://doi.org/10.21315/jps2018.29.s2.6>

ABSTRACT: *A novel configuration of photovoltaic-thermoelectric generator hybrid system (PV-TEG) device is proposed. This device integrates the system with a beam spectral splitter. This beam is called a hot mirror in which a shorter wavelength will be transmitted to PV module, while the longer one is for the TEG module. A mini USB Thermospectrometer software is used to measure the wavelength connecting to laptop webcam. The heat radiation for the PV-TEG will be enhanced by sidewalls covered with a black painted plastic acrylic material leading to high conversion efficiency. This is because the material minimises heat losses of the light. The hybrid device uses artificial suns, namely light bulbs as an irradiation source located at the top of the system. Xenon, halogen and incandescent lights are chosen as light bulbs. These choices are based on some of the hybrid researchers. No experimental scenarios for those lamps are in laboratory scale. From the test, it has been showed that incandescent light bulb contributes the highest heat radiation of 54.76 W.nm and the lowest heat radiation is 25.65 W.nm by halogen before the hot mirror. After passing through the hot mirror, xenon light emits the highest visible light spectrum of about 479 nm, while halogen in range of 800 nm releases near-infrared, which is more needed by TEG.*

Keywords: Spectral irradiance, hot mirror, wavelength, PV-TEG, photovoltaic-thermoelectric

1. INTRODUCTION

Currently, people utilise more than 80% of natural resources derived from fossil fuels, namely oil, coal and natural gas. These are finite natural resources which are depleting at a rapid rate. While there are reports estimating that the fossil fuel reserves are enough for centuries, the effect of diminishing reserves will be felt much sooner. This is because many of these reserves are unconventional, which means that the extraction process is much more challenging and expensive. As a result, the supply-demand relationship is no longer elastic. Therefore, it is necessary to cope by looking for renewable energy sources that are abundant, free and do not pollute. Solar is the most promising source of energy which can be converted into electrical energy in various applications relying on an increase in efficiency and inexpensive technology.

Photovoltaic (PV) and thermoelectric generator (TEG) are semiconductor modules that can convert solar energy sources into electrical power by combining the two modules for increasing power output and their efficiencies. Unfortunately, the characteristics of PV require spectrum solar energy in short wavelength in terms of photons, namely ultraviolet and visible light, while TEG needs long wavelengths in the form of heat, i.e., near-infrared (NIR) and infrared (IR). In other words, PV needs photons energy approaching its band gap cell as shown in Figure 1 as explained by Leque and Hegedus.¹

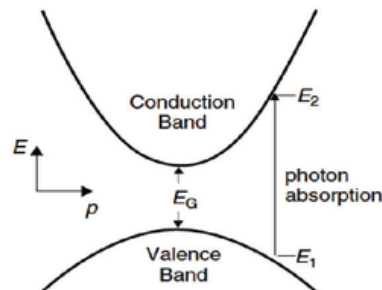
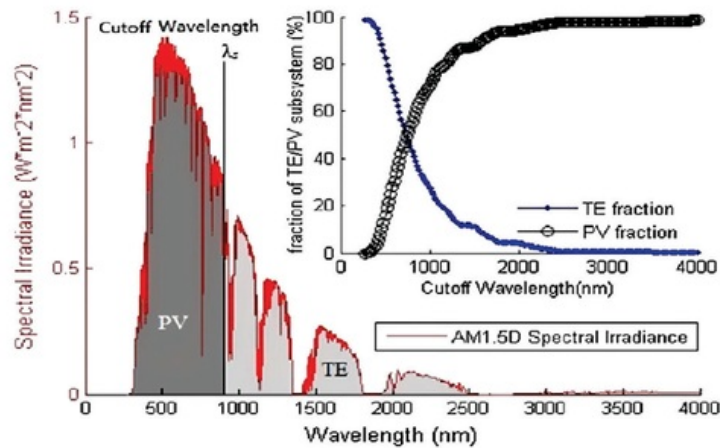

Figure 1: Photon absorption in a direct bandgap semiconductor for an incident photon with energy $h\nu = E_2 - E_1 > E_g$, with h Plank's constant and ν speed of light.

Some studies on hybrid of PV-TEG which separated the wavelengths have been reported. Ju et al. conducted numerical analysis and optimisation of hybrid PV-TEG through simulation in which the modelling combined Fresnel lenses, glass dichroic, solar cell type of GaAs and TEG type of skutterudites (CoSb_3) with an area that is considered to be the same, using heat sink as a coolant in the PV and TEG.² Basically, the separation of the spectrum works on solar concentration and high temperatures. By using a beam splitter, solar radiation in units of W m^{-2} (E_{in})

vided into two wavelengths at the intersection of wave ($\lambda_s = 770nm$), where ETE is the irradiance at wavelengths of λ_s up to 4000 nm and EPV is in the range between 280 and λ_s nm, as apparent in spectrum group of AM1.5D, depicted in Figure 2. More details about solar cell and TEG efficiency on the spectrum group can be referred to Kraemer et al.¹¹



3

Figure 2: Segmentation of AM1.5D spectrum in two regions of the CPV and TEG subsystems. The inset shows the converted power fraction of each subsystem when the cutting of wavelength point increases.

η_{opt} is the optical efficiency¹⁸ system, C_g is a geometric concentration ratio of Fresnel lens whose value is the³ ratio of the surface area of the Fresnel lens and TE thermal collectors or PV; $C_g = A_{HC}/A_F = A_{PV}/A_F$ where A_{HC} , A_{PV} and A_F are respectively the collector surface area of heat on the TE, the solar cell area and a Fresnel lens surface area, with $A_{HC} = A_{PV}$.

Meanwhile, Mizoshiri et al. fa¹⁴cted thermoelectric module measuring 18×18 mm of the thin-film type $Bi_0: 5Sb_1: 5Te_3$ (p-type) and $Bi_2Te_2: 7Se_0: 3$ (n-type) which combined with the solar cell modu⁷ of Sanyo Electric (amorphous Silicon).⁴ To determ⁷ine the best dimensions and surface temperature distribution of the TE module, Finite Element Method (FEM), with COMSOL Multiphysics v4.1, was used. The hot mirror was used to split the UV and VIS, and NIR (or IR). The reflection of IR on the hot mirror was again focused with cylindrical lens before being transmitted to ¹⁶ TE, while the UV and VIS lights were directed to the photovoltaic cell. The surface temperature of the hot PV mirror was $46^\circ C$, while without the hot mirror the temperature reached $50^\circ C$. In this hybrid, copper heatsink with 3-dimensional variations was used as a coolant in TEG and PV

where the influence can be seen in the simulation. As a result, the hybrid voltage of PV-TEG increased by 1.3% compared with PV star⁷ alone. Unfortunately, the TEG output power decreased by 0.006% of PV power. The temperature difference between the hot and cold sides of the TEG was only 20°C.⁴

Elsarrag et al. in their study used cold mirror to split solar radiation. The principal difference is its working and economic costs.⁵ The cold mirror was mounted at 45° angle in which the IR spectrum solar radiation was transmitted, while UV and VIR were reflected. The obstacle is that mirror is much more expensive than the hot mirror. They carried out theoretical and experimental studies to enhance the performance of hybrid PV-TEG. However, the design of the test did not consider other light radiations that go into hybrid systems for PV-TEG modules. This is because the system did not cover light radiation from outside. This will affect the total radiation that splits and reaches the surface of both modules.

All designs on these references were modified by optimising the utilisation of artificial sun radiation from some types of light bulbs in laboratory scale. The proposed design is mostly suitable for indoor use and laboratory scale.

2. EXPERIMENTAL

This study will design and construct a hybrid model of PV-TEG using artificial suns as radiation energy. The design model is depicted in Figure 3, where at the top model, the light was capped by material to protect spreading the lamp radiations. Basically, hot mirror's elevation could be changed from 0° to 45° as shown in Figure 3 (Edmund Optics).⁸ Our proposed design is set at 45° angle of incidence in order to split VIS and IR. These high-performance hot mirrors feature a multi-layer dielectric coating optimised for greater than 90% transmission of visible light and greater than 95% reflection of IR wavelengths.

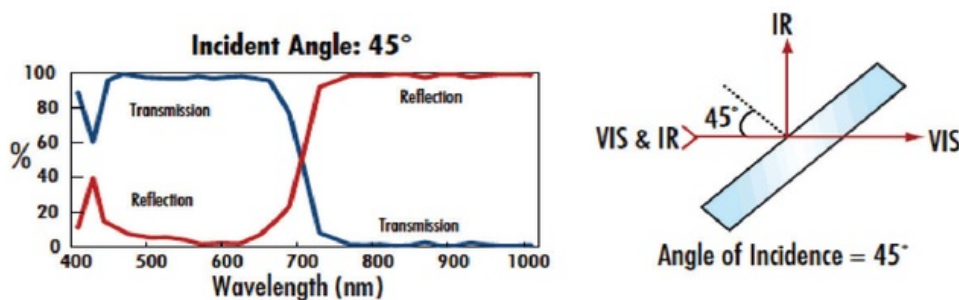

Figure 3: Technical images on hot mirror, where angle of incidence = 45°.

The sidewalls of the designed system were covered with white painted acrylic material to protect other light sources and increase heat radiation simultaneously as shown in Figure 4.

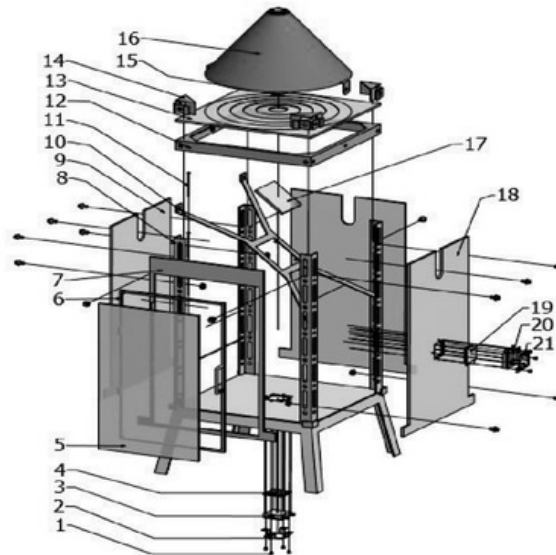
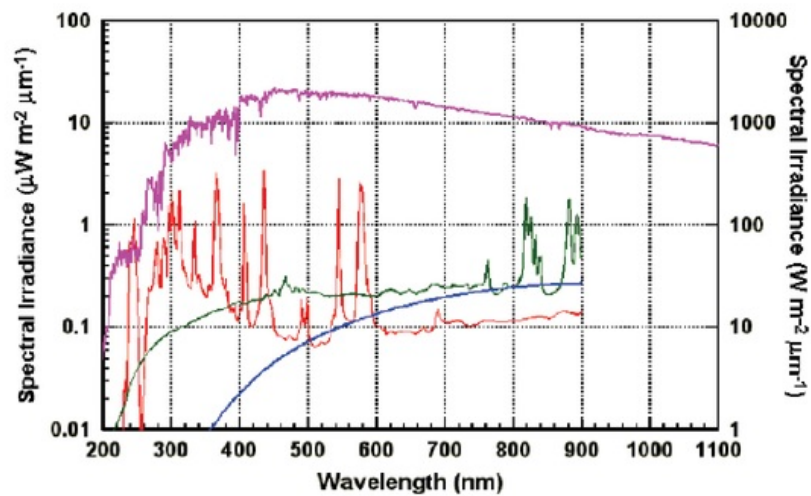

Figure 4: Hybrid configuration of PV-TEG with hot mirror in laboratory scale.

In the illustration, 1–4 = PV module, heat sink and absorber; 5 = acrylic plastic black painted; 6 = fasteners; 7 = aluminum mounts base; 8 = hybrid frame; 9–11 = hot mirror frame; 12 = Fresnel lens; 13 and 14 = Fresnel lens; 15 = light bulb; 16 = light cover head; 17 = hot mirror; 18 = TEG module stand; 19–21 = TEG module, heat sink and absorber.

The selection of the artificial suns was based on the study of Doolittle that considers the mercury, xenon and halogen bulbs approaching the solar spectrum as depicted in Figure 5.⁶ Xenon has the most approaching Sun's spectral irradiance, while mercury's light has a random spectrum at the beginning of its irradiance till 600 nm in wavelength. For halogen, it starts having a shorter wavelength over 300 nm.



6

Figure 5: The spectral irradiance of xenon (green), halogen (blue) and mercury (red) light bulbs (left axis) compared to spectral irradiance from the sun (purple, corresponding to the right axis).

Furthermore, the dimensions of PV and TEG modules are considerably the same. It is desirable that the module area procures the same irradiation area with the bulb. To do that, firstly, the distance among the light bulb, Fresnel lens and PV module will be arranged in a manner based on the module area. Secondly, hot mirror position is set up at an angle of 45° from the horizontal line that covers light bulb radiation transmitting to PV module below the mirror.

With reference to the Fresnel lens, it has specification of a focal length in 182 mm, dimension 235×235 mm, groove pitch 0.5 mm, 3 mm thickness, CPV, with the PMMA materials placed under the cone cover.⁸ This lens is a concentrator to improve the number of suns leading to increasing PV cell efficiency as described in Figure 6.¹ Heat radiation through the lens will be captured and split by the hot mirror as a wavelength spectrum beam splitting. The mirror type is HM-VS-1500 with extreme hot performance mirrors offering enhanced UV blocking. The average transmittance is $T \geq 85\%$ $T \leq 1\%$ 420–680 nm and 200–380 nm, while reflection on the average number of $R \geq 95\%$ 730–1500 nm from Abrisa Technology.^{3,7}

In the vertical line below the mirror is a mini solar cell PV of an epoxy system with dimensions 40×40 mm with 0.5 W, 5 V and 100 mA. This cell is acquired from online commercial platform Ebay.com. On the right side of the system, TEC1-12706 is installed.

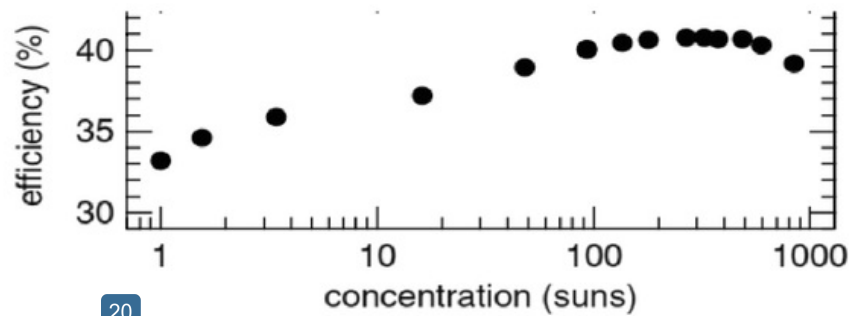

20
Figure 6: Efficiency of three PV cell junctions as a function of concentration.⁸

2.1 Radiation through Fresnel Lens

The amount of heat radiated by the light bulb passing through the Fresnel lens is calculated using the formula:

$$Q_{emit} = \epsilon \sigma A (T_s^4 - T_{air}^4) [W] \quad (1)$$

10
where ϵ is the emissivity of the surface, σ is Stephan-Boltzmann constant ($5.670 \times 10^{-8} \text{ W m}^{-2} \text{ K}^{-4}$), A is area of the surface in m^2 , T_s is absolute temperature of the surface in K, and T_{air} is surrounding temperature in K.

Since the radiation passes through the hot mirror in the form of wavelength (λ), then Equation 1 becomes:

$$\int_{\lambda_1}^{\lambda_2} \epsilon A \sigma (T_s^4 - T_{air}^4) \partial \lambda \quad (2)$$

The magnitude of the wavelengths (λ_1 and λ_2) are based on measurements using the Theremino Spectrometer V2.3 in which has an interval wavelength from 400 nm to more than 700 nm.

3. WORKING MECHANISM

In Figure 7, the position of the bulbs is placed inside a cone-shaped cover in order to reduce heat losses to surrounding. The distance between Fresnel lens and the mirror is adapted to the extent of the falling light on the mirror dimension. The hot mirror will separate lamp heat radiation, where the short wavelengths (UV and VILS) will be transmitted to the cell underneath, while the long wavelength (NIR-IR) will be reflected thermoelectrically. With the specification of the mirror

average transmittance, $T_A \geq 85\%$, 420 – 680 nm and 200 – 380 nm $T_A \leq 1\%$ will be transmitted to the PV, while reflecting TEG at average rate $R_A \geq 95\%$, 730 – 1500 nm. The amount of light radiation and the temperature will be measured by solar power meter TENMARS and digital thermometer, respectively. The solar meter will measure that the solar cells receive the light radiation in 1000 W m^{-2} . The surface temperature of PV cell and thermoelectric is measured with a 5-sensor digital thermocouple. Power generated by PV-TEG system is measured with a power meter. The procedure will be adopted for 3 types of 100 W light bulbs, namely incandescent, xenon and halogen.

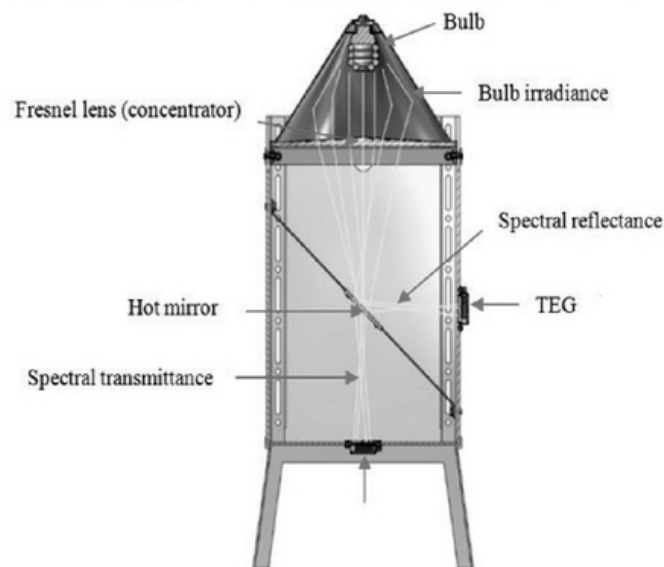

Figure 7: Hybrid of PV-TEG with hot mirror as wavelength spectrum splitter

Heat radiation of the bulb is collected by the Fresnel lens focusing and transmitting to the hot mirror. The two modules will be irradiated by the artificial suns through the hot mirror in two wavelengths spectrum based on the mirror specification as mentioned. The spectrum wavelength will be measured with a mini USB spectrometer connecting to a laptop using Theremino spectrometer software. This spectrometer has a light detector of at least 300 pixels and is usable in the visible range of the spectrum based on the webcam's catch from the light. Thus, spectral splitting would be analysed. The geometric concentration ratio of the lens is determined by $C_g = A_{TEG}/A_F = A_{PV}/A_F$ where A_{TEG} , A_{PV} and A_F are thermoelectric module surface area, surface area of the solar cell and the lens area.²

Furthermore, after testing with artificial suns as heat irradiation, the system will be tested for certain conditions under the sun to compare the results. Unfortunately,

due to the hybrid design configuration obstacles, outdoor testing under solar radiation can only be done at certain times. In terms of the power generated by TEG, the same parameters will be considered in completing our proposed system as explained by Goldsmid.⁹

4. RESULTS AND DISCUSSION

4.1 Wavelength Spectrum of Lights Passing through Hot Mirror

The observed spectrum of the wavelength of light passing through the Fresnel lens and HM is shown in Table 1. The table shows spectrum ranges on 3 types of lamps, i.e., xenon, halogen and incandescent at 100 W lamp power. At the same wavelength of about 479 nm (VIS), the xenon light spectrum shows the highest intensity followed by incandescent. For wavelengths entering the NIR range of about 800 nm, halogen light displays the highest intensity. This indicates that xenon lights correspond to more PV characteristics requiring shorter wavelengths (VIS), while NIRs are more needed by TEGs.

The determination of the limit of the wavelength integral of light can be referred to Cengel and Ghajar as depicted in Table 2. The light ranges are visible lights.¹⁰

Table 2: The wavelength ranges of different colours.

Colour	Wavelength band (μm)
Violet	0.40–0.44
Blue	0.44–0.49
Green	0.49–0.54
Yellow	0.54–0.60
Orange	0.60–0.67
Red	0.63–0.76

Table 1: Spectrum range of different light bulbs passes through HM.

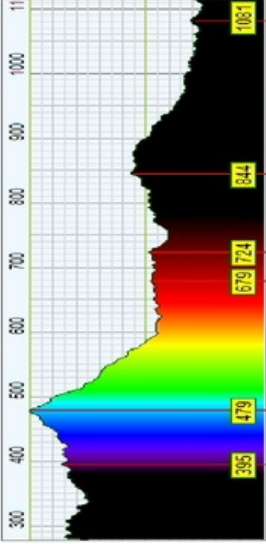
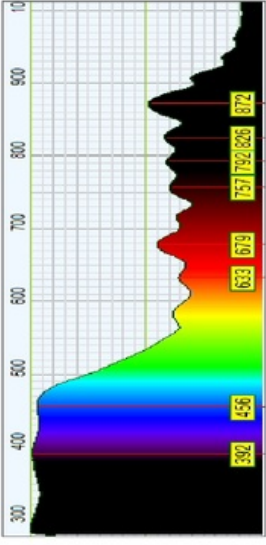
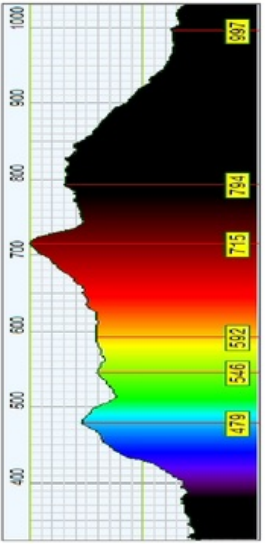
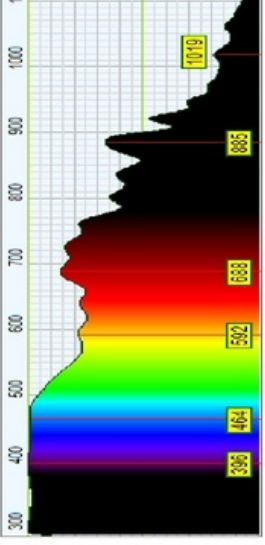
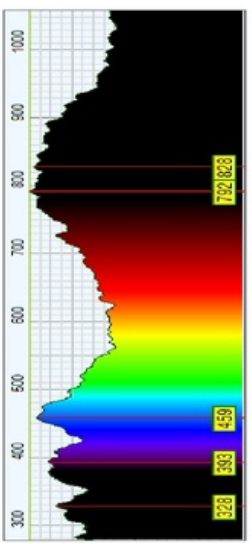
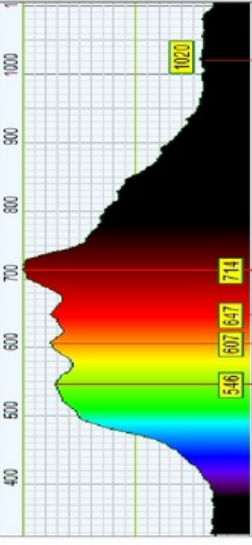
Light bulbs (100 W)	Spectrum ranges	
	Transmittance spectrum wavelength impinges on PV	Reflectance spectrum wavelength impinges on TEG
Xenon	 <p>395 479 519 724 844 1081</p>	 <p>392 456 633 673 757 792 826 872</p>
Halogen	 <p>479 540 592 715 794 897</p>	 <p>396 464 592 688 885 1019</p>
Incandescent	 <p>328 383 459 732 823</p>	 <p>546 607 647 714 1020</p>

4.2 The Amount of Heat Radiated by the Light Bulb in the Form of Wavelength Before Hot Mirror

By using Equation 2 and based on Table 1, the amount of heat radiated by the bulbs is as follows:

$$Q_{emit} = \int_{\lambda=400}^{\lambda=419} \in A\sigma(T_s^4 - T_{air}^4)\partial\lambda + \int_{\lambda=419}^{\lambda=429} \in A\sigma(T_s^4 - T_{air}^4)\partial\lambda + \int_{\lambda=429}^{\lambda=443} \in A\sigma(T_s^4 - T_{air}^4)\partial\lambda + \dots + \int_{\lambda=705}^{\lambda=730} \in A\sigma(T_s^4 - T_{air}^4)\partial\lambda \quad (3)$$

The wavelength's integral boundary is the same for each lamp type, so the total radiation of heat produced is 319.06 W.nm (incandescent lights) with the distribution of heat shown in Figure 8.

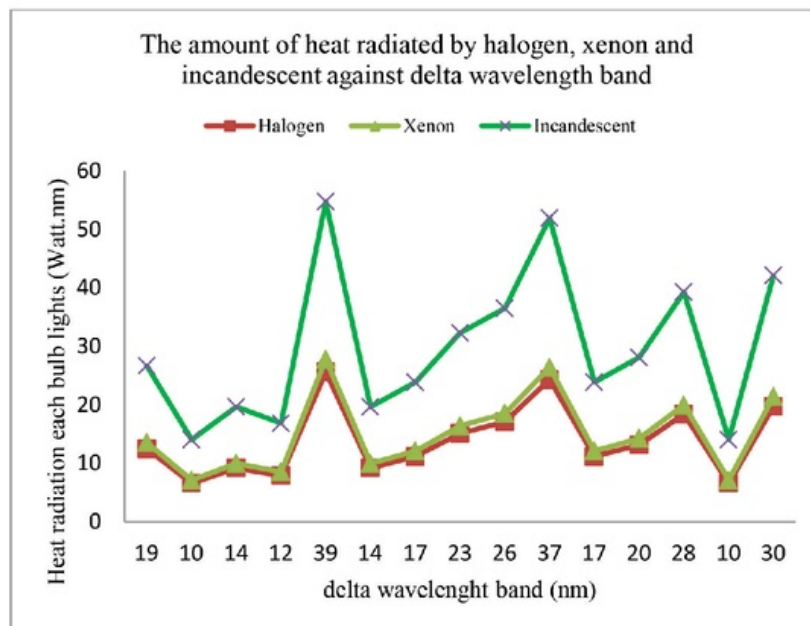

Figure 8: Heat radiation of halogen, xenon and incandescent in the formed wavelength in 60 min.

Figure 8 shows that the incandescent lamp produces the highest heat radiation in the wavelength form, whereas the halogen produces the lowest. The maximum heat produced by incandescent is 54.76 W.nm and minimum is 14.04 W.nm. Xenon

lamp produces a maximum power of 27.80 W.nm and a minimum of 7.12 W.nm. On the other hand, the smallest halogen heat bulb is 6.58 W.nm and the largest is 25.65 W.nm.

5. CONCLUSION

The paper has demonstrated the hybrid system of a PV-TEG using artificial suns as heat irradiation, namely xenon, halogen and incandescent light lamps. The incandescent light lamp shows the best heat radiation prior to hot mirror introduction during the experiments. The average heat radiation generated by the bulbs are 13.85, 15.02 and 29.58 W.nm, respectively. The test has been conducted for 60 min and each second the data was recorded. However, after passing through the hot mirror, the wavelength spectrum [4](#) at emits the best photons is the xenon light for the PV, while TEGs that require long wavelengths of around 800 nm are emitted by halogen lamps.

6. ACKNOWLEDGEMENTS

Acknowledgement is extended to Edi Iskandar, one of the Mechanical Engineering laboratory personnel (Universitas Hasanuddin, Indonesia) for all efforts in setting up the experiments, as well as Muhammad Widiyanto and Mulya Miladina for their assistance during the measurements on the spectrometer. This research was self-funded by the authors.

7. REFERENCES

1. Leque, A. & Hegedus, S. (2011). *Photovoltaic science handbook of photovoltaic science*. New York: John Wiley & Sons.
2. Ju, X. et al. (1954). Numerical analysis and optimization of a spectrum splitting concentration photovoltaic – thermoelectric hybrid system. *Sol. Energy*, 86(6), 1941–1954.
3. Karp, J. H. & Ford, J. E. (2008). Multiband solar concentrator using transmissive dichroic beamsplitting. Proceedings of SPIE 7043; High and Low Concentration for Solar Electric Applications III, 70430F, 9 September, <https://doi.org/10.1117/12.793906>.
4. Mizoshiri, M., Mikami, M. & Ozaki, K. (2012). Thermal-photovoltaic hybrid solar generator using thin-film thermoelectric modules. *Jap. J. Appl. Phys.*, 51(6), 1–5.

5. Elsarrag, E. et al. (2015). Spectrum splitting for efficient utilization of solar radiation: A novel photovoltaic–thermoelectric power generation system. *Renew. Wind. Water Solar*, 2(16), 1–11, <https://doi.org/10.1186/s40807-015-0016-y>.
6. Doolittle, A. (2007). Lecture 2: The nature of light. Retrieved from http://users.ece.gatech.edu/~alan/ECE4833/Lectures/Lecture2_PropertiesOfSunlight.pdf on 1 July 2017.
7. Edmund Optics. (2017). Hot mirror. Retrieved from <https://www.edmundoptics.com/optics/optical-mirrors/specialty-mirrors/hot-mirrors/> on 17 August 2017.
8. Ebay. (2017). Fresnel lens CP182-235 concentrate photovoltaic solar cooking converging lens. Retrieved from <https://www.ebay.com/itm/FRESNEL-LENS-CP182-235-Concentrate-Photovoltaic-SOLAR-COOKING-Converging-lens/301880318426?hash=item46497819da:g:SYAAOSwT6pVsgnO> on 10 March 2017.
9. Goldsmid, H. J. (2009). *Introduction to thermoelectricity*. London: Springer.
10. Cengel, Y. A. & Ghajar, Y. J. (2015). *Heat and mass transfer*, 5th ed. New York: McGraw Hill.
11. Kraemer, D. et al. (2008). Photovoltaic-thermoelectric hybrid systems: A general optimization methodology. *Appl. Phys. Lett.*, 92, 1–3.

A New Hybrid of Photovoltaic-thermoelectric Generator with Hot Mirror as Spectrum Splitter

ORIGINALITY REPORT

% **17**
SIMILARITY INDEX

% **9**
INTERNET SOURCES

% **12**
PUBLICATIONS

% **5**
STUDENT PAPERS

PRIMARY SOURCES

1 repository.tudelft.nl %**2**
Internet Source

2 Mustofa, Basri, Yuli Asmi Rahman. "Experimental investigation from different focal length of Fresnel lens on thermoelectric generators performance", IOP Conference Series: Earth and Environmental Science, 2018 %**2**
Publication

3 Xing Ju, Zhifeng Wang, Gilles Flamant, Peng Li, Wenyu Zhao. "Numerical analysis and optimization of a spectrum splitting concentration photovoltaic–thermoelectric hybrid system", Solar Energy, 2012 %**2**
Publication

4 Samson Shittu, Guiqiang Li, Yousef Golizadeh Akhlaghi, Xiaoli Ma, Xudong Zhao, Emmanuel Ayodele. "Advancements in thermoelectric generators for enhanced hybrid photovoltaic system performance", Renewable and Sustainable Energy Reviews, 2019 %**2**
Publication

5	Submitted to University of Kufa Student Paper	% 1
6	orca.cf.ac.uk Internet Source	% 1
7	Mizoshiri, Mizue, Masashi Mikami, and Kimihiro Ozaki. "Thermal–Photovoltaic Hybrid Solar Generator Using Thin-Film Thermoelectric Modules", Japanese Journal of Applied Physics, 2012. Publication	% 1
8	www.mjms.usm.my Internet Source	% 1
9	www.hrsacademy.in Internet Source	% 1
10	www.civil.canterbury.ac.nz Internet Source	% 1
11	Qian Wang, Kazunari Domen. "Particulate Photocatalysts for Light-Driven Water Splitting: Mechanisms, Challenges, and Design Strategies", Chemical Reviews, 2019 Publication	% 1
12	P Taba, P Budi, A Y Puspitasari. "Adsorption of heavy metals on amine-functionalized MCM-48", IOP Conference Series: Materials Science and Engineering, 2017 Publication	% 1
13	ejournal.stipwunaraha.ac.id	

Internet Source

% 1

14

link.springer.com

Internet Source

<% 1

15

www.tlsr.usm.my

Internet Source

<% 1

16

www.mdpi.com

Internet Source

<% 1

17

Submitted to Galveston College

Student Paper

<% 1

18

ecommons.usask.ca

Internet Source

<% 1

19

web.usm.my

Internet Source

<% 1

20

Da, Yun, Yimin Xuan, and Qiang Li. "From light trapping to solar energy utilization: A novel photovoltaic–thermoelectric hybrid system to fully utilize solar spectrum", *Energy*, 2016.

Publication

<% 1

21

Ding Liang, Qi Luo, Peng Li, Yayu Fu, Lanlan Cai, Pengchen Zhai. "Optimization and experimentation of concentrating photovoltaic/cascaded thermoelectric generators hybrid system using spectral beam splitting technology", *IOP Conference Series: Earth and Environmental Science*, 2018

<% 1

EXCLUDE QUOTES ON

EXCLUDE
BIBLIOGRAPHY ON

EXCLUDE MATCHES < 5
WORDS